

LIGHTING CATALOG

2025

SINCE 2015

EYTON GROUP

BRING YOU MORE PROFIT

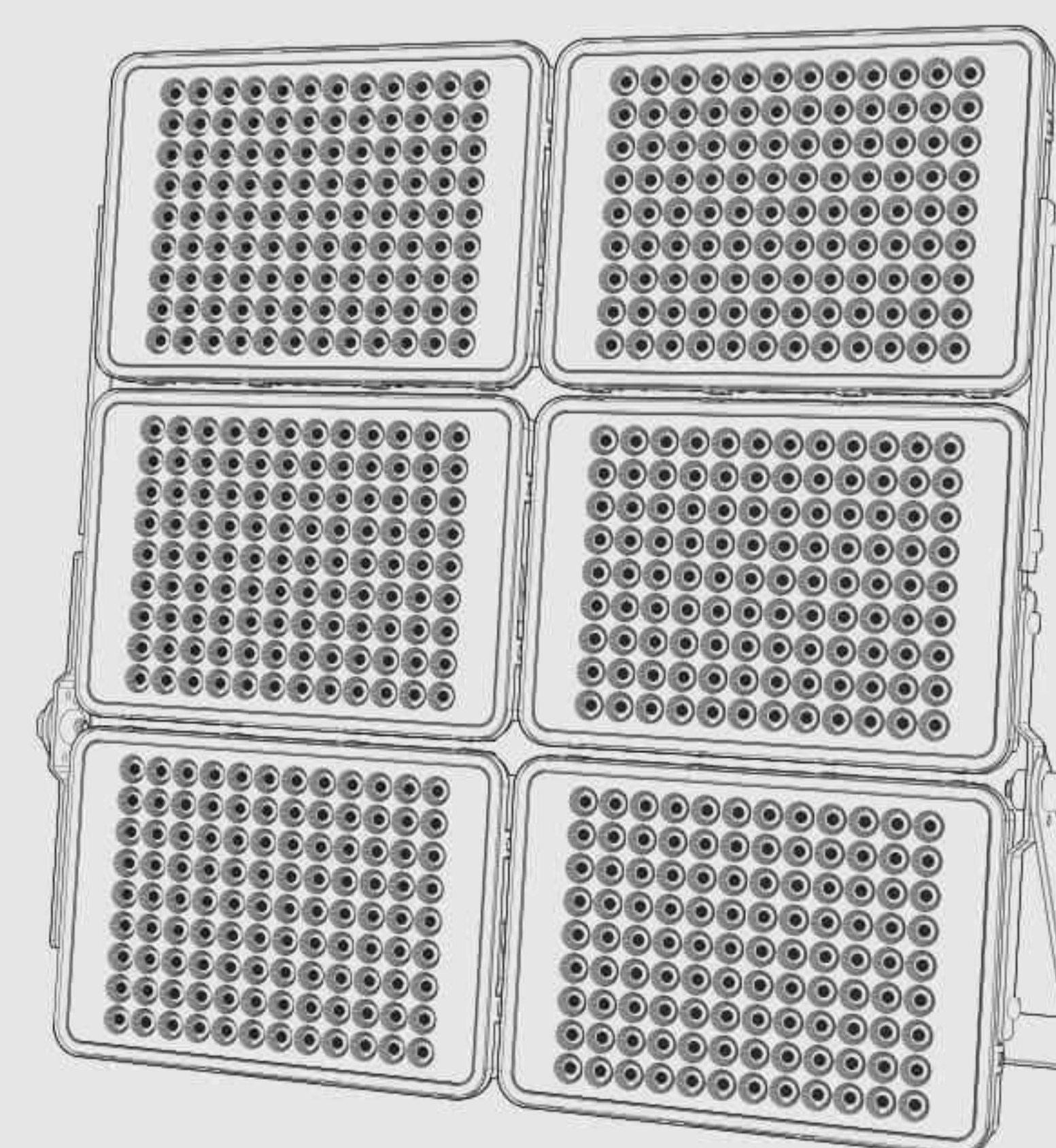

EYTON GROUP

COMPANY INFORMATION



> 10 YEARS EXPERIENCE



ISO9001/ BSCI / CE / ROHS
ERP / TIS / INMETRO



STRONG R&D CAPACITY

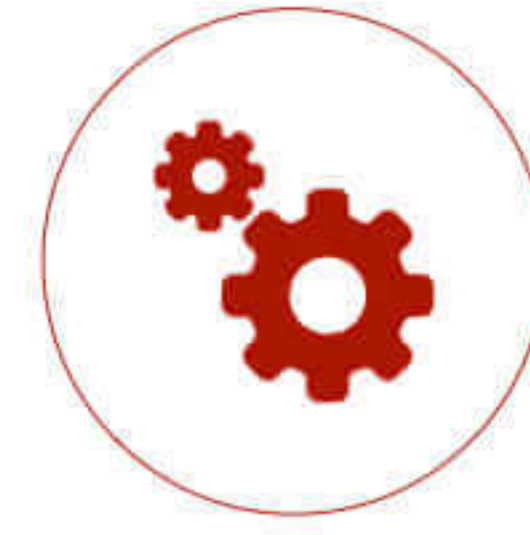

26 AUTOMATIC LINES



OUTDOOR / INDDOR LIGHTING



7-10% INCREASE

FACTORY



Automatic assembly & packing lines
Aging lines



LAB

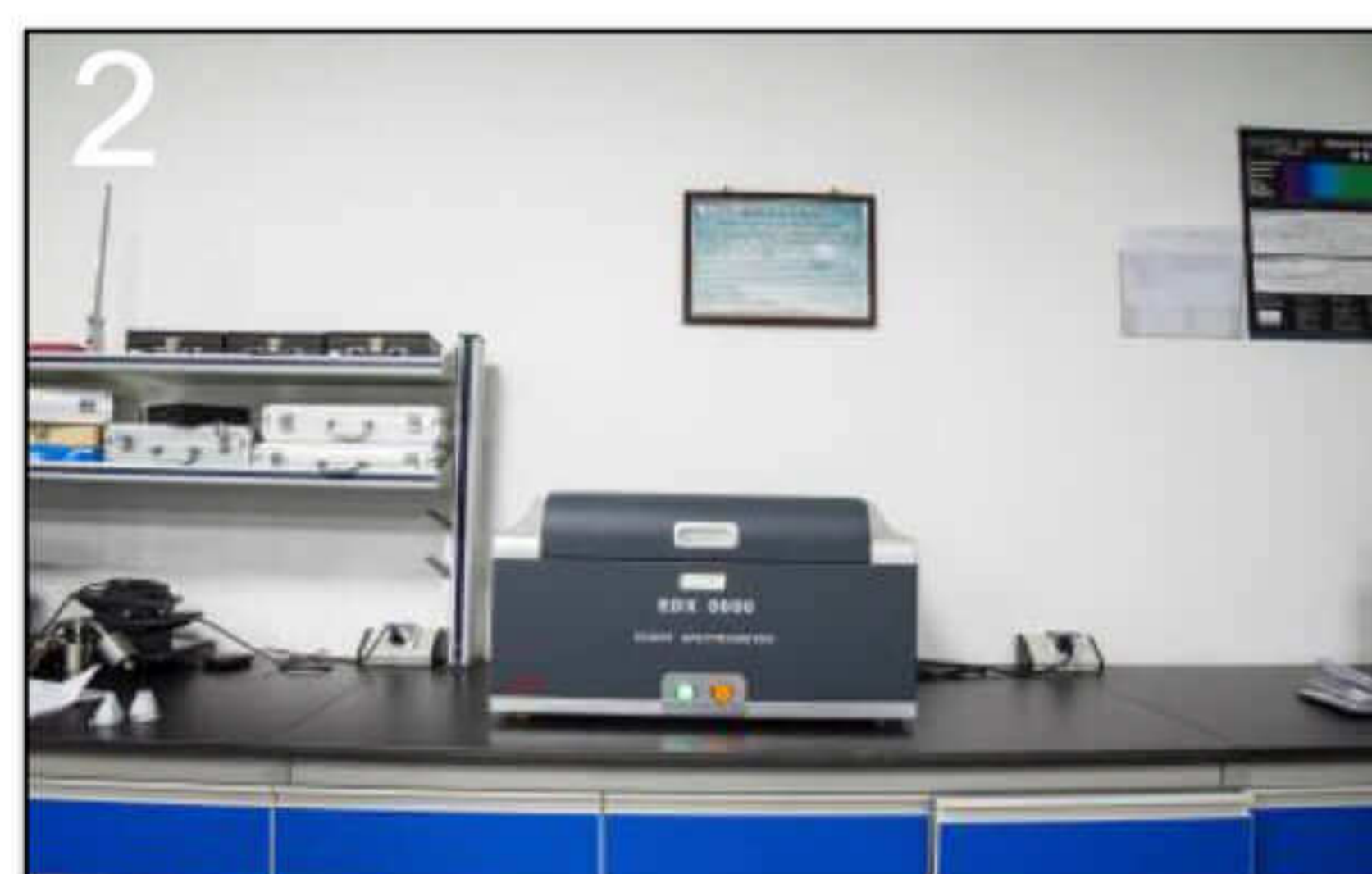

1.LED photoelectric performance lab
2. RoHS lab
3.Environmental reliability lab

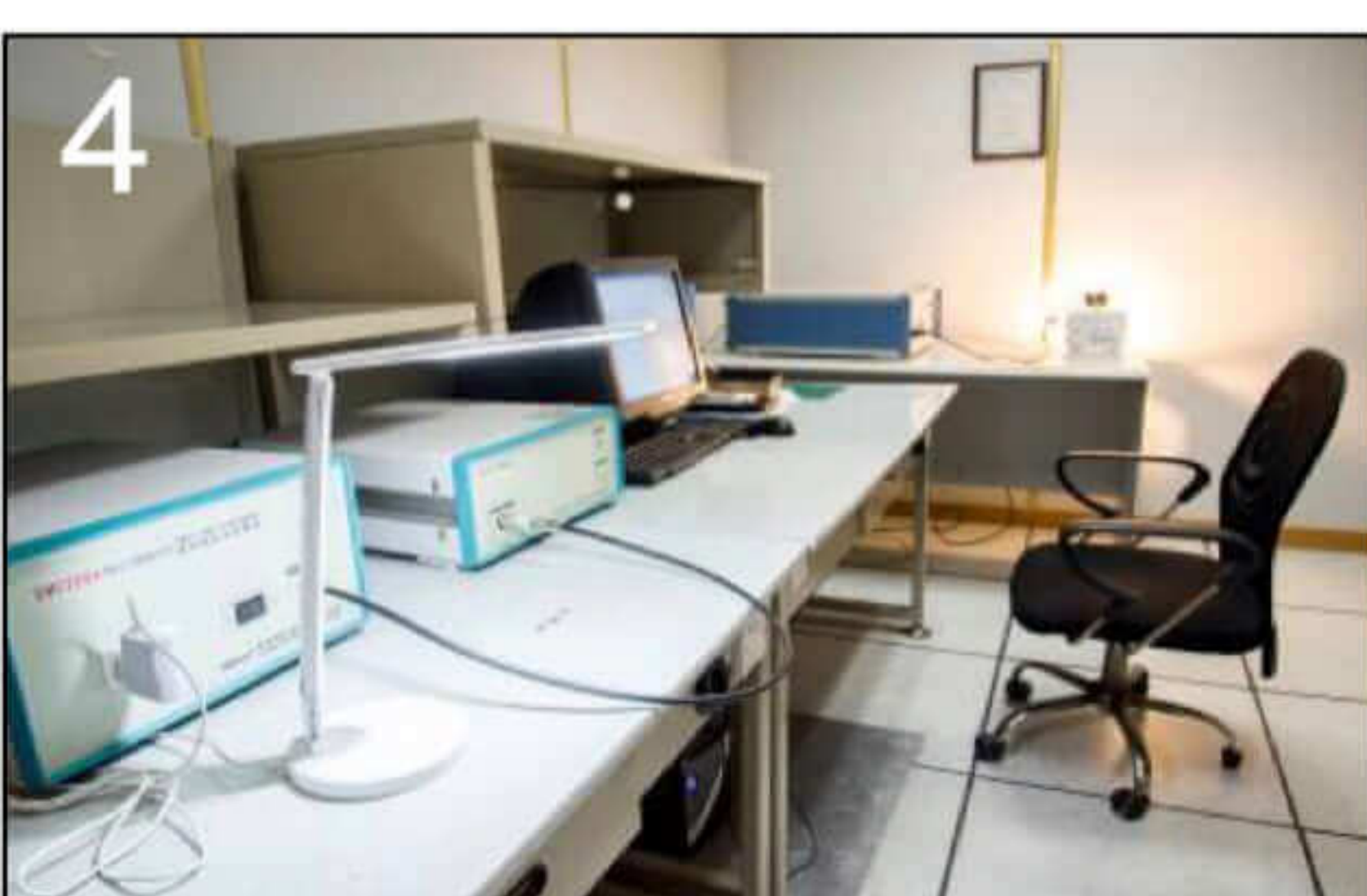

4.EMC lab
5.Safety electronics lab
6.Waterproof lab

LED OUTDOOR LIST

LED FLOODLIGHT



ECO



STANDARD I



PREMIUM

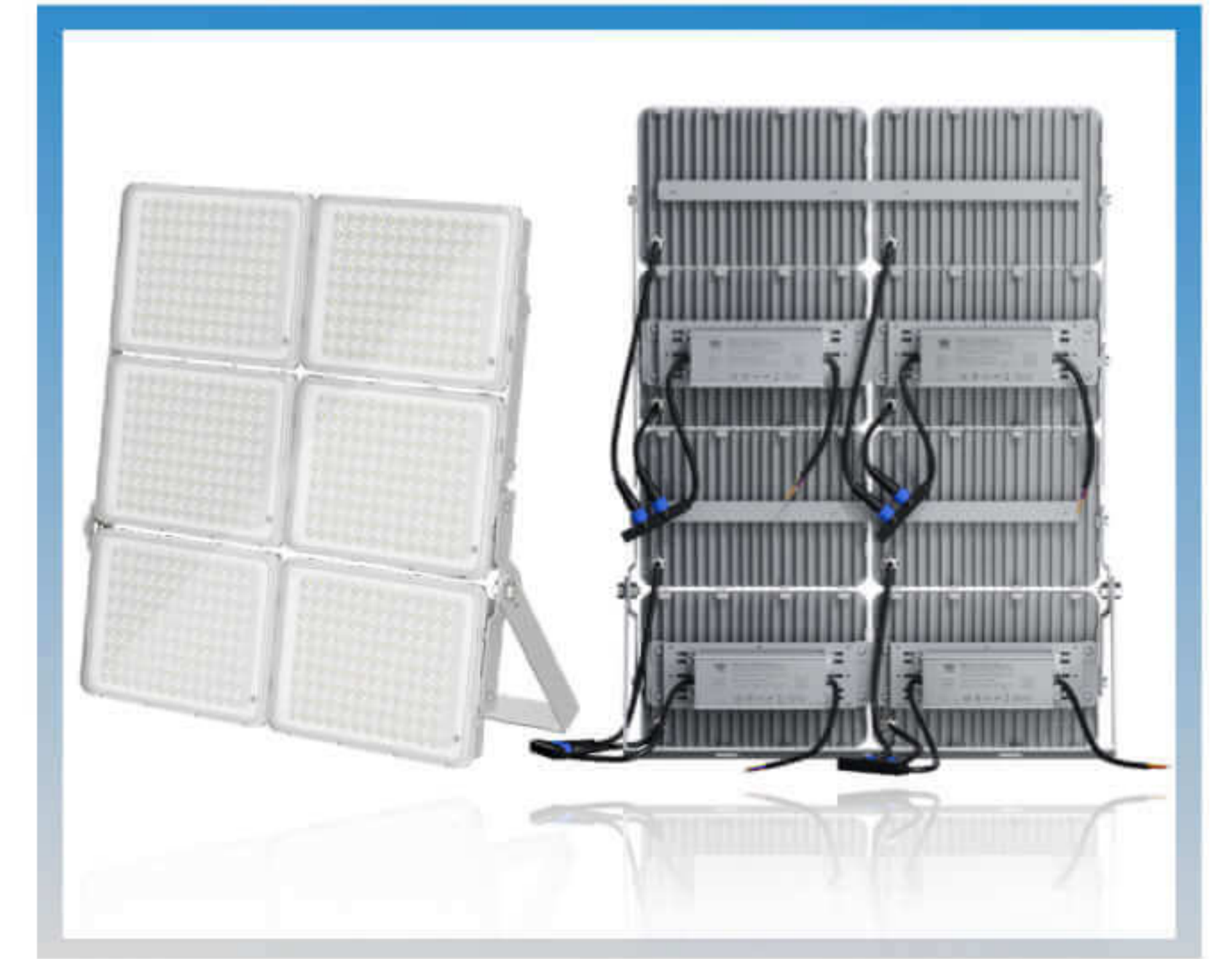

LED MODULE PRO

LED HIGH BAY



NEW MATERIAL



ECO



STANDARD

LED STREET LIGHT



ECO



PRO

LED BARN LIGHT



PRO

LED SHAPEABLE TRACK LIGHT



PROFESSIONAL

LED FLOODLIGHT



SERIES

10W / 20W / 30W / 50W / 70W / 100W /
150W / 200W / 300W / 400W / 500W / 600W

2 YEARS

25000hrs



PIR SENSOR



WHITE OPTION

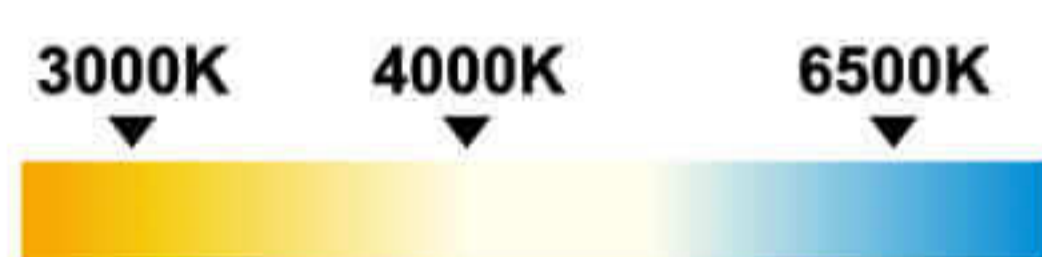

SPECIFICATION

ET-FL-10WDM

10w
AC 220-240V
90lm/w
Ra(CRI) > 80
PF ≥ 0.9
Linear IC Driver
Size: 85*63*24.5mm

ET-FL-20WDM

20w
AC 220-240V
90lm/w
Ra(CRI) > 80
PF ≥ 0.9
Linear IC Driver
Size: 114.3*80.3*24.5mm

ET-FL-30WDM

30w
AC 220-240V
90lm/w
Ra(CRI) > 80
PF ≥ 0.9
Linear IC Driver
Size: 143.6*100*25mm

ET-FL-50WDM

50w
AC 220-240V
90lm/w
Ra(CRI) > 80
PF ≥ 0.9
Linear IC Driver
Size: 177.7*125.3*26.7mm

ET-FL-70WDM

70w
AC 220-240V
90lm/w
Ra(CRI) > 80
PF ≥ 0.9
Linear IC Driver
Size: 224*157.5*27.3mm

ET-FL-100WDM

100w
AC 220-240V
90lm/w
Ra(CRI) > 80
PF ≥ 0.9
Linear IC Driver
Size: 266*190*30mm

ET-FL-150WDM

150w
AC 220-240V
90lm/w
Ra(CRI) > 80
PF ≥ 0.9
Linear IC Driver
Size: 321*222*34.5mm

ET-FL-200WDM

200w
AC 220-240V
90lm/w
Ra(CRI) > 80
PF ≥ 0.9
Linear IC Driver
Size: 385*265*34.5mm

LED FLOODLIGHT



NJX series
50W / 100W / 150W
200W / 300W

BJX series
10W / 20W / 30W / 50W /
100W / 150W / 200W /

2 YEARS
25000hrs

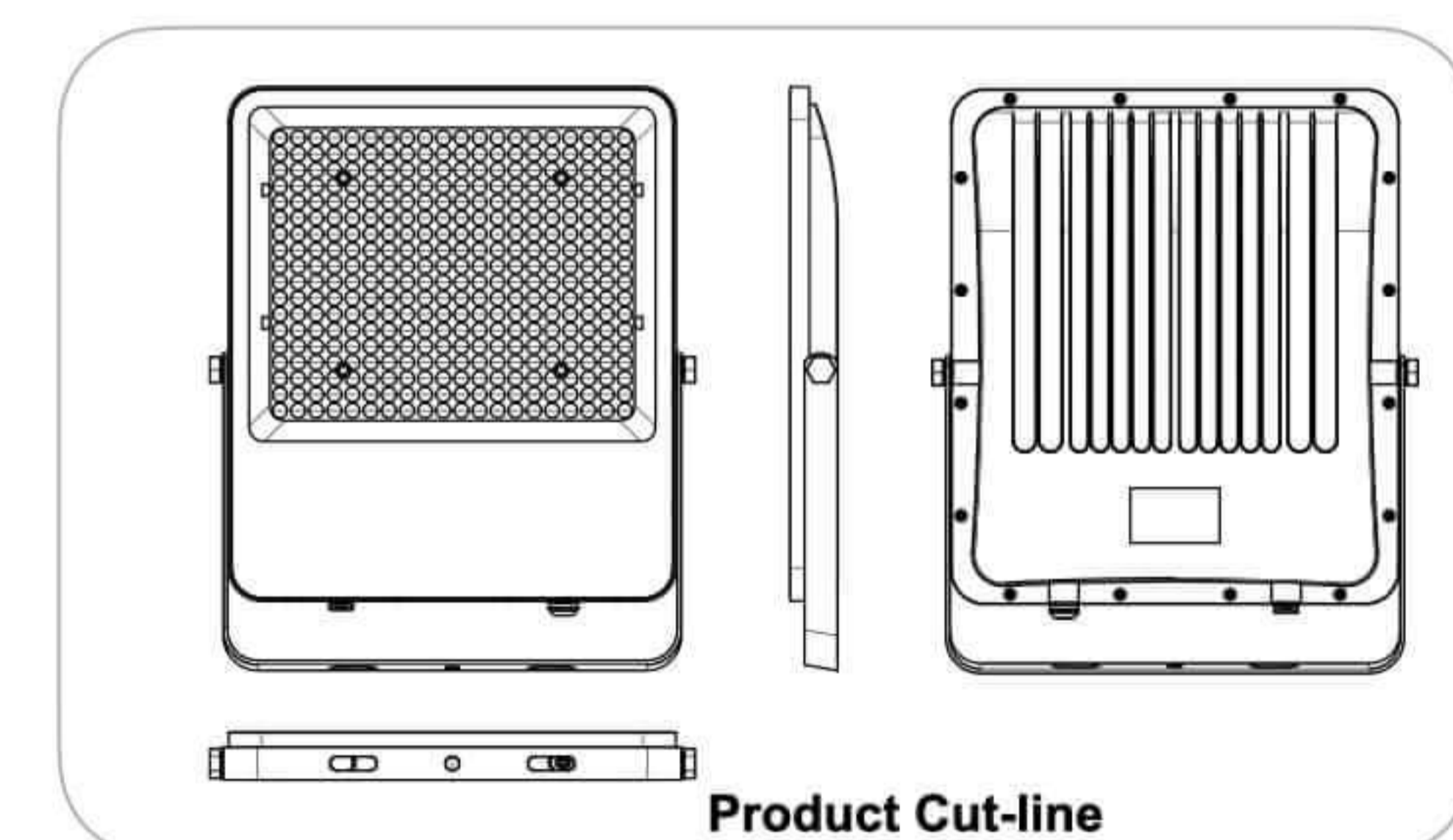
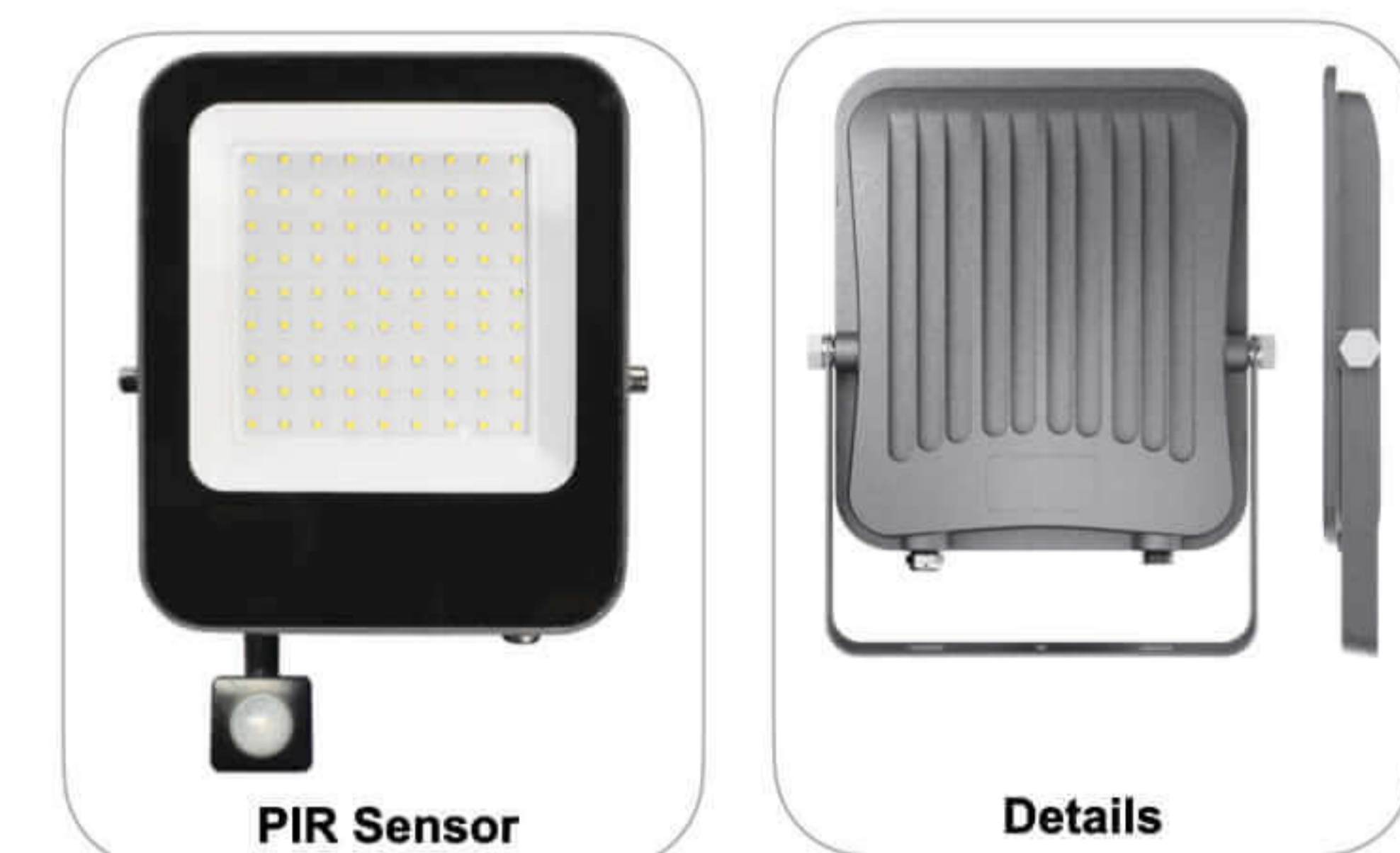

SPECIFICATION

ET-FL-10WBJX

10w
AC 220-240V
90lm/w
Ra(CRI) > 80
PF≥0.9
IC Driver
Size: 100*85*21mm

ET-FL-20WBJX

20w
AC 220-240V
90lm/w
Ra(CRI) > 80
PF≥0.9
IC Driver
Size: 120*103*21mm

ET-FL-30WBJX

30w
AC 220-240V
90lm/w
Ra(CRI) > 80
PF≥0.9
IC Driver
Size: 156*135*26mm

ET-FL-50WBJX

50w
AC 220-240V
90lm/w
Ra(CRI) > 80
PF≥0.9
IC Driver
Size: 191*164*30mm

ET-FL-100WBJX

100w
AC 220-240V
90lm/w
Ra(CRI) > 80
PF≥0.9
IC Driver
Size: 231*198*30mm

ET-FL-150WBJX

150w
AC 220-240V
90lm/w
Ra(CRI) > 80
PF≥0.9
IC Driver
Size: 267*230*31mm

ET-FL-200WBJX

200w
AC 220-240V
90lm/w
Ra(CRI) > 80
PF≥0.9
IC Driver
Size: 386*265*31mm

ET-FL-50WNJX

50w
AC 220-240V
90lm/w
Ra(CRI) > 80
PF≥0.9
IC Driver
Size: 202*173*26mm

ET-FL-100WNJX

100w
AC 220-240V
90lm/w
Ra(CRI) > 80
PF≥0.9
IC Driver
Size: 254*220*28mm

ET-FL-150WNJX

150w
AC 220-240V
90lm/w
Ra(CRI) > 80
PF≥0.9
IC Driver
Size: 313*265*30mm

ET-FL-200WNJX

200w
AC 220-240V
90lm/w
Ra(CRI) > 80
PF≥0.9
IC Driver
Size: 342*298*35mm

ET-FL-300WNJX

300w
AC 220-240V
90lm/w
Ra(CRI) > 80
PF≥0.9
IC Driver
Size: 376*328*35mm



IP65	CE	RoHS		
SERIES 10W / 20W / 30W / 50W / 100W / 150W / 200W /		ISOLATED DRIVER		5 YEARS 50000hrs



Back Side



Details



SPECIFICATION

ET-FL-10WTG3B

10w
AC 200-240V
115lm/w
Ra(CRI) > 80
PF ≥ 0.5
Isolated Driver
Size: 166*116*32mm

ET-FL-20WTG3B

20w
AC 200-240V
115lm/w
Ra(CRI) > 80
PF ≥ 0.9
Isolated Driver
Size: 216*160*40mm

ET-FL-30WTG3B

30w
AC 200-240V
115lm/w
Ra(CRI) > 80
PF ≥ 0.9
Isolated Driver
Size: 226*175*40mm

ET-FL-50WTG3B

50w
AC 200-240V
115lm/w
Ra(CRI) > 80
PF ≥ 0.9
Isolated Driver
Size: 310*228*50mm

ET-FL-100WTG3B

100w
AC 200-240V
115lm/w
Ra(CRI) > 80
PF ≥ 0.9
Isolated Driver
Size: 403*330*61mm

ET-FL-150WTG3B

150w
AC 200-240V
115lm/w
Ra(CRI) > 80
PF ≥ 0.9
Isolated Driver
Size: 431*371*60mm

ET-FL-200WTG3B

200w
AC 200-240V
115lm/w
Ra(CRI) > 80
PF ≥ 0.9
Isolated Driver
Size: 471*401*60mm

LED FLOODLIGHT MODULE



5 YEARS
50000hrs

>140
Lm/w

IP66

IK08

SERIES

200W / 300W / 400W / 600W / 800W

Wire Connection

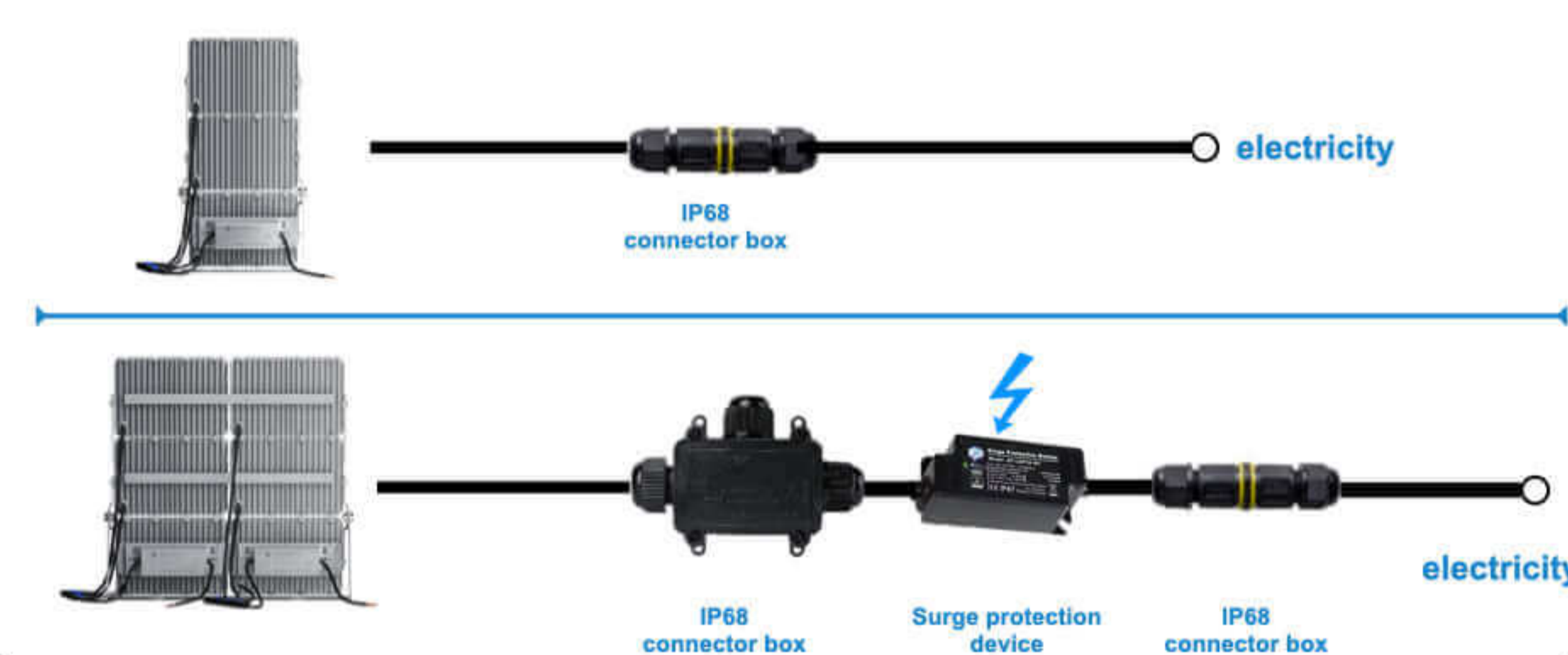

RoHS



Grey



Black

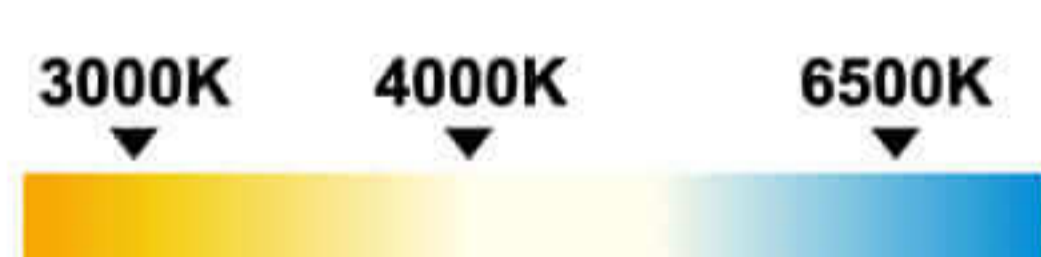

SPECIFICATION

ET-FV-D-200W

200w
120-277V
140lm/w
PF≥0.95
Flicker free
5 years warranty
Size: 416x310x25mm

ET-FV-D-300W

300w
120-277V
140lm/w
PF≥0.95
Flicker free
5 years warranty
Size: 614x310x25mm

ET-FV-D-400W

400w
120-277V
140lm/w
PF≥0.95
Flicker free
5 years warranty
Size: 590x420x35mm

ET-FV-D-600W

600w
120-277V
140lm/w
PF≥0.95
Flicker free
5 years warranty
Size: 620x590x35mm

ET-FV-D-800W

800w
120-277V
140lm/w
PF≥0.95
Flicker free
5 years warranty
Size: 840x590x35mm

NEW MATERIAL
LED HIGHBAY



Graphene Highbay



SPECIFICATION

ET-HB100W-HSD

100W
200-260V
100LM/W
SPD>4Kv
PF>0.9
DOB Driver
Size: Φ277xH40mm

ET-HB150W-HSD

150W
200-260V
100LM/W
SPD>4Kv
PF≥0.9
DOB Driver
Size: Φ310xH40mm

ET-HB200W-HSD

200W
200-260V
100LM/W
SPD>4Kv
PF≥0.9
DOB Driver
Size: Φ357xH40mm

ECO
LED HIGHBAY

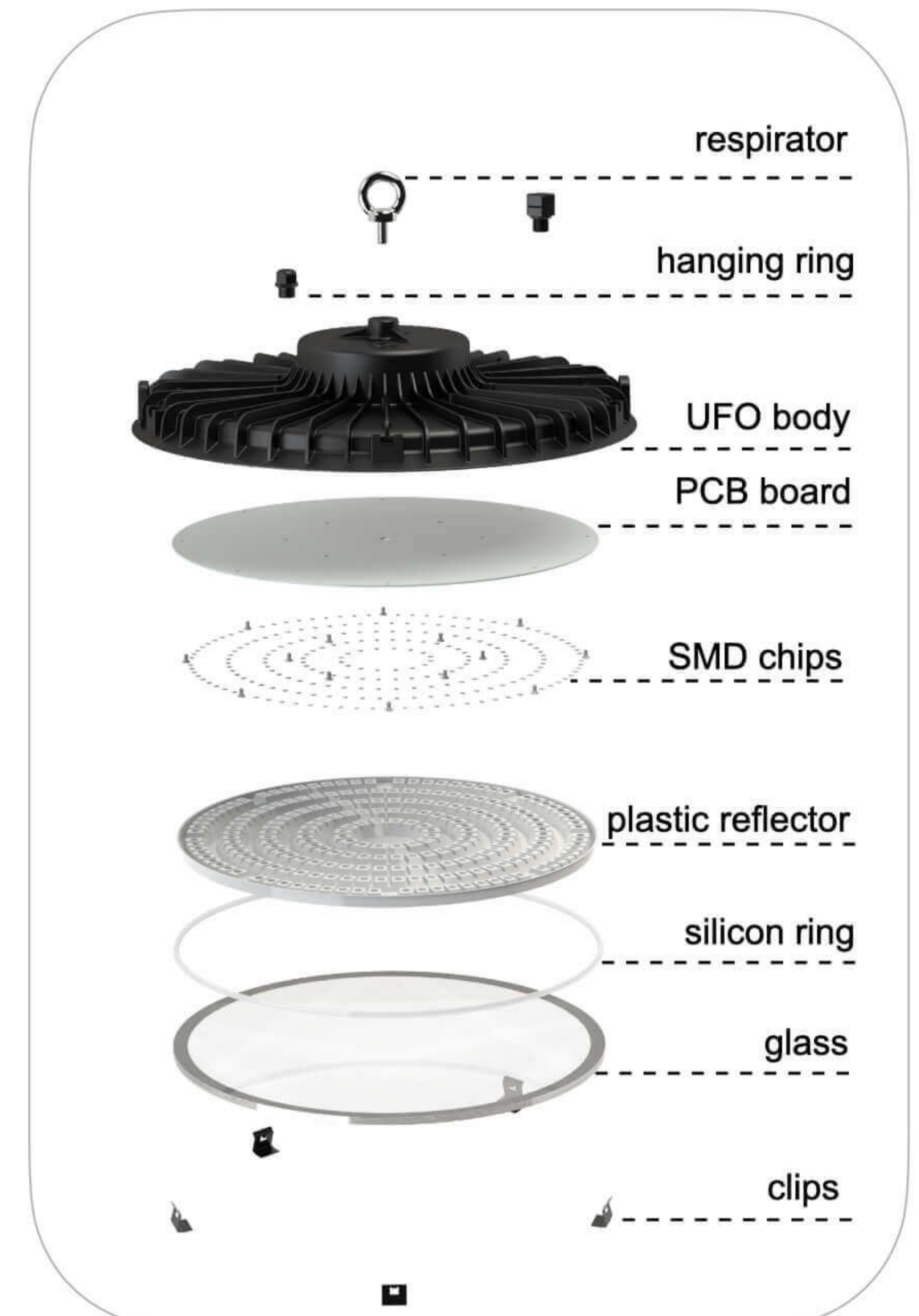
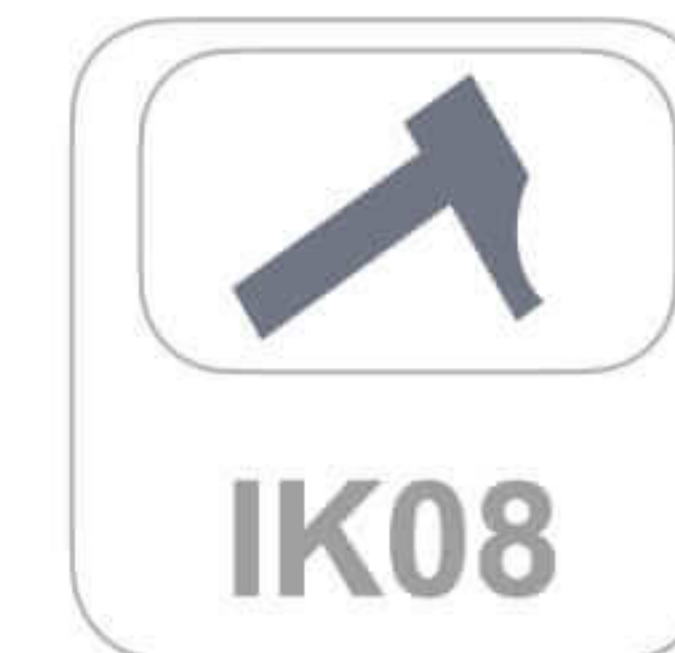

EXPLODED DIAGRAM



SPECIFICATION

ET-HB100W-HY

100w
175-250V
100lm/w
Ra(CRI) > 80
PF > 0.9
SPD > 4Kv
IC/DOB Driver
Size: Φ237*90mm
Beam Angle: 90°

ET-HB150W-HY

150w
175-250V
100lm/w
Ra(CRI) > 80
PF > 0.9
SPD > 4Kv
IC/DOB Driver
Size: Φ300*96mm
Beam Angle: 90°

ET-HB200W-HY

200w
175-250V
100lm/w
Ra(CRI) > 80
PF > 0.9
SPD > 4Kv
IC/DOB Driver
Size: Φ360*96mm
Beam Angle: 90°

STANDARD

LED HIGHBAY

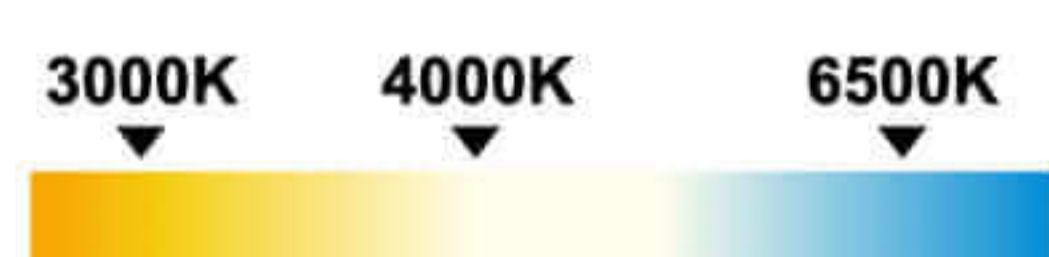

SPECIFICATION

ET-HB100W-HVD

100W
200-260V
100LM/W
SPD>3.5Kv
PF≥0.95
DOB/IC Driver
Size: Φ260xH35mm

ET-HB150W-HVD

150W
200-260V
100LM/W
SPD>3.5Kv
PF≥0.95
DOB/IC Driver
Size: Φ310xH35mm

ET-HB200W-HVD

200W
200-260V
100LM/W
SPD>3.5Kv
PF≥0.95
DOB/IC Driver
Size: Φ345xH35mm

ECO

LED STREET LIGHT

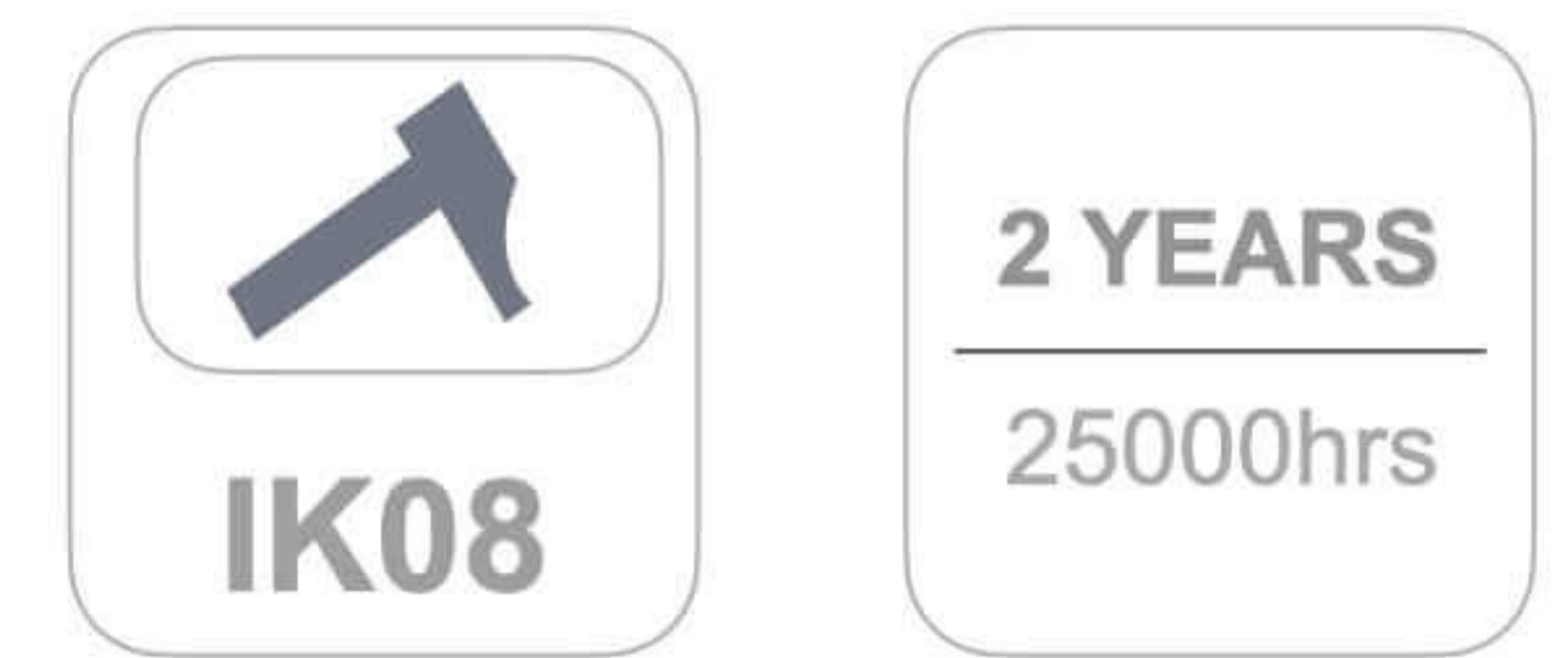

SPECIFICATION

ET-SL50W-SC

50W
AC120-265V
90-100LM/W
Ra>80
SPD>4Kv
PF>0.9
DOB Driver
Size: 362x145x62mm

ET-SL100W-SC

100W
AC120-265V
90-100LM/W
Ra>80
SPD>4Kv
PF>0.9
DOB Driver
Size: 486x165x62mm

ET-SL150W-SC

150W
AC120-265V
90-100LM/W
Ra>80
SPD>4Kv
PF>0.9
DOB Driver
Size: 545x206x72mm

ET-SL200W-SC

200W
AC120-265V
90-100LM/W
Ra>80
SPD>4Kv
PF>0.9
DOB Driver
Size: 623x235x72mm

LED STREET LIGHT



SPECIFICATION

ET-SL50W-SV

50W
 AC120-265V
 120-150LM/W
 Ra>80
 SPD>6Kv
 PF>0.9
 IC Driver
 Size: 485x210x70mm

ET-SL100W-SV

100W
 AC120-265V
 120-150LM/W
 Ra>80
 SPD>6Kv
 PF>0.9
 IC Driver
 Size: 538x238x102mm

ET-SL150W-SV

150W
 AC120-265V
 120-150LM/W
 Ra>80
 SPD>6Kv
 PF>0.9
 IC Driver
 Size: 602x276x105mm

ET-SL200W-SV

200W
 AC120-265V
 120-150LM/W
 Ra>80
 SPD>6Kv
 PF>0.9
 IC Driver
 Size: 697x311x112mm

PRO LED BARN LIGHT

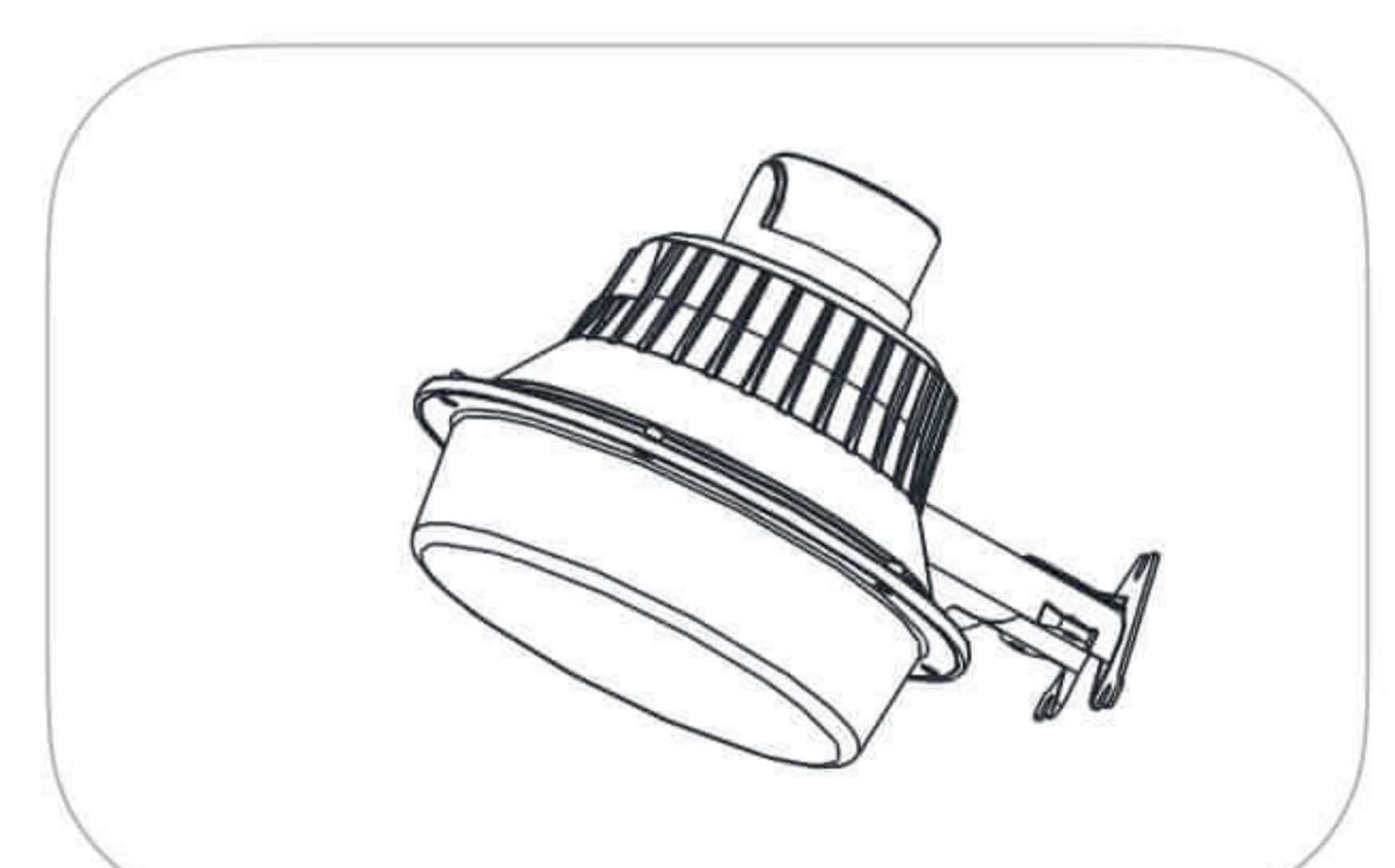
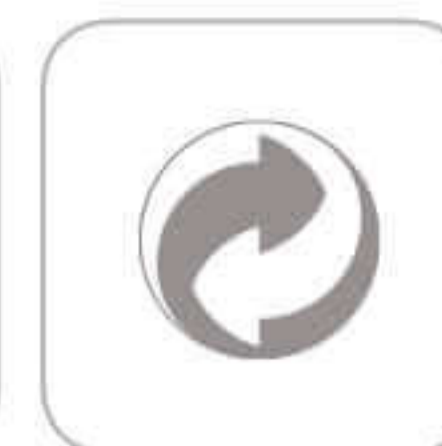

SPECIFICATION

ET-BL-50WI

50w
100-305V
100-110lm/w
Ra(CRI)≥70
PF≥0.9
Isolated driver
50000 hours
5 years
Size: 295.1*242.2*110mm

ET-BL-50WDOB

50w
200-240V
100-110lm/w
Ra(CRI)≥70
PF≥0.9
DOB driver
35000 hours
3 years
Size: 295.1*242.2*110mm

ET-BL-300WSOLAR

30w
Battery type: 3.2V 20000MAH
Solar panel: 24W
Working pattern:
light sensor + time + remote control
Working time: 2--3 rainy days
Beam Angle: 120°

OPTIONS

Each model with 3 choices:
1:Normal light
2:small photocell
3:big photocell (above blue one)

LED SHAPEABLE TRACK LIGHT



Industrial Grade Optical Filter



VIP exclusive custom collar

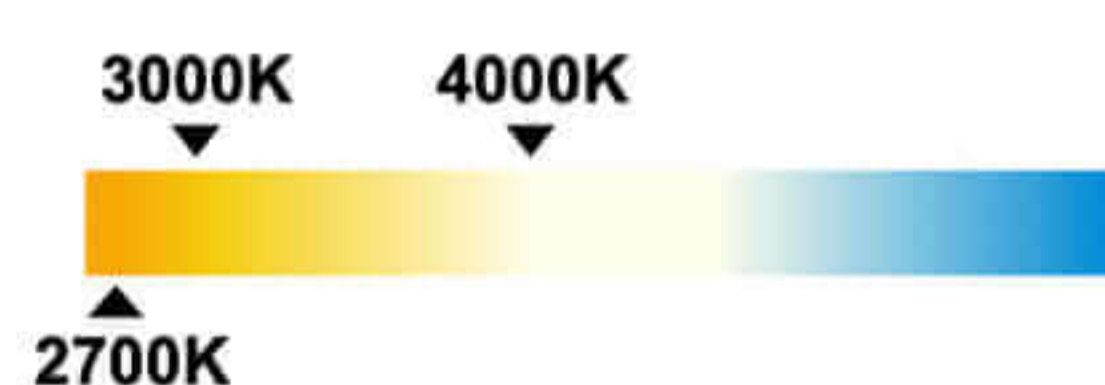
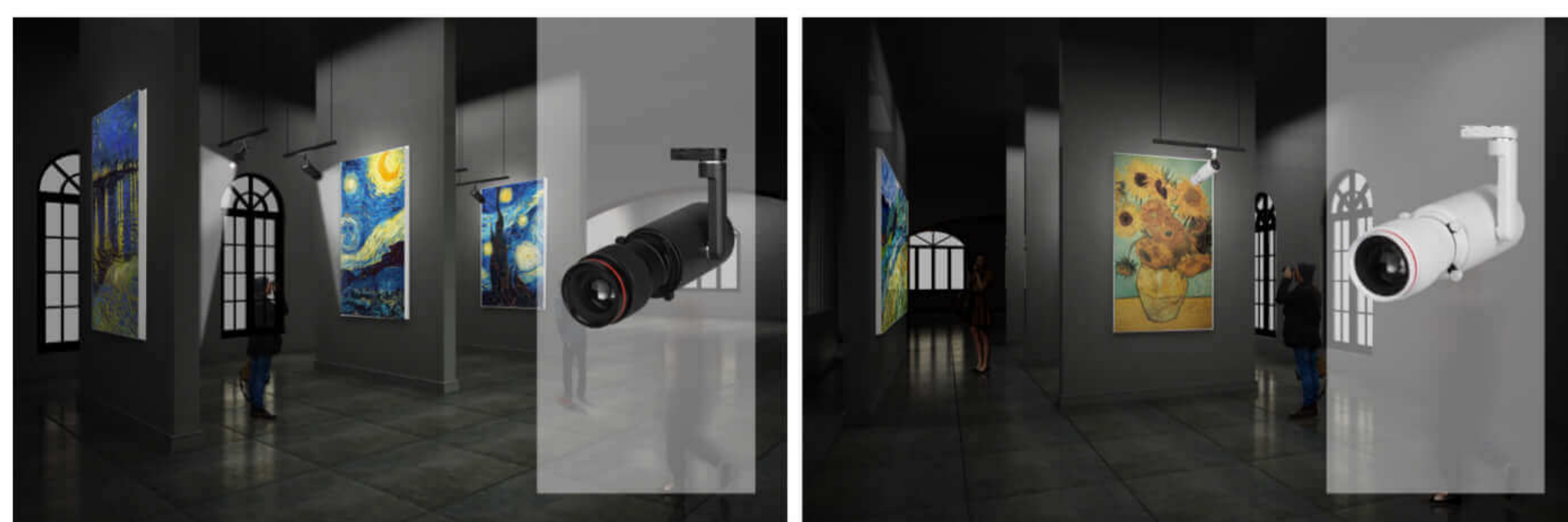

SPECIFICATION

ET-STL-T1008S

10W
 Zoom range: 15°~25° / 25°~36°
 300~350LM
 Ra≥97
 CCT: 2700K/3000K/4000K
 PF≥0.95
 Casing color: Black/White
 Filter: 37mm

ET-STL-T2008S

20W
 Zoom range: 15°~25° / 20°~36°
 650~750LM
 Ra≥97
 CCT: 2700K/3000K/4000K
 PF≥0.95
 Casing color: Black/White
 Filter: 67mm

ET-STL-T3008S

28W
 Zoom range: 15°~25° / 20°~36°
 850~950LM
 Ra≥97
 CCT: 2700K/3000K/4000K
 PF≥0.95
 Casing color: Black/White
 Filter: 67mm

ET-STL-T4008S

37W
 Zoom range: 15°~25° / 20°~36°
 300~350LM
 Ra≥97
 CCT: 2700K/3000K/4000K
 PF≥0.95
 Casing color: Black/White
 Filter: 67mm

LED COMMERCIAL LIST

CCT & W Adjustable

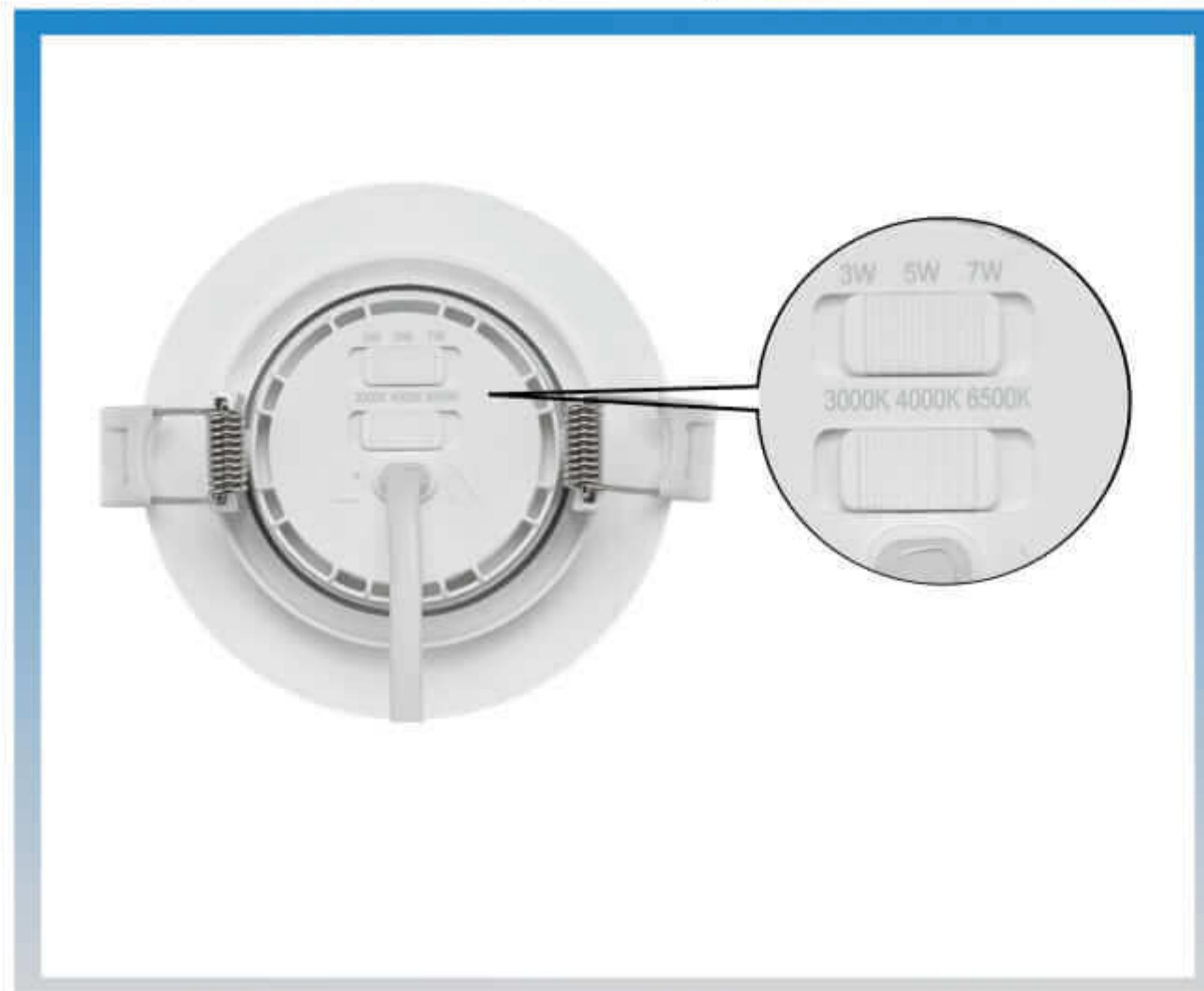

ET-NFP-2

DOWNLIGHT



ET-PDL-1

CEILING LIGHTING

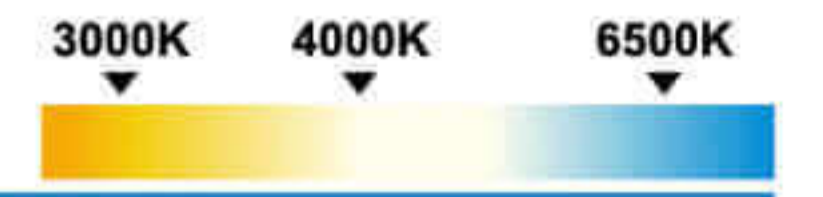

ET-SCL-CCT



ET-SP6060-2. SIDE



ET-BSP6060-1. BACKLIT



ET-SP-1 / ET-SP-2



DOWNLIGHT



FRAME FOR SPOTLIGHT-2



FRAME FOR SPOTLIGHT-1

Power & CCT Adjustable

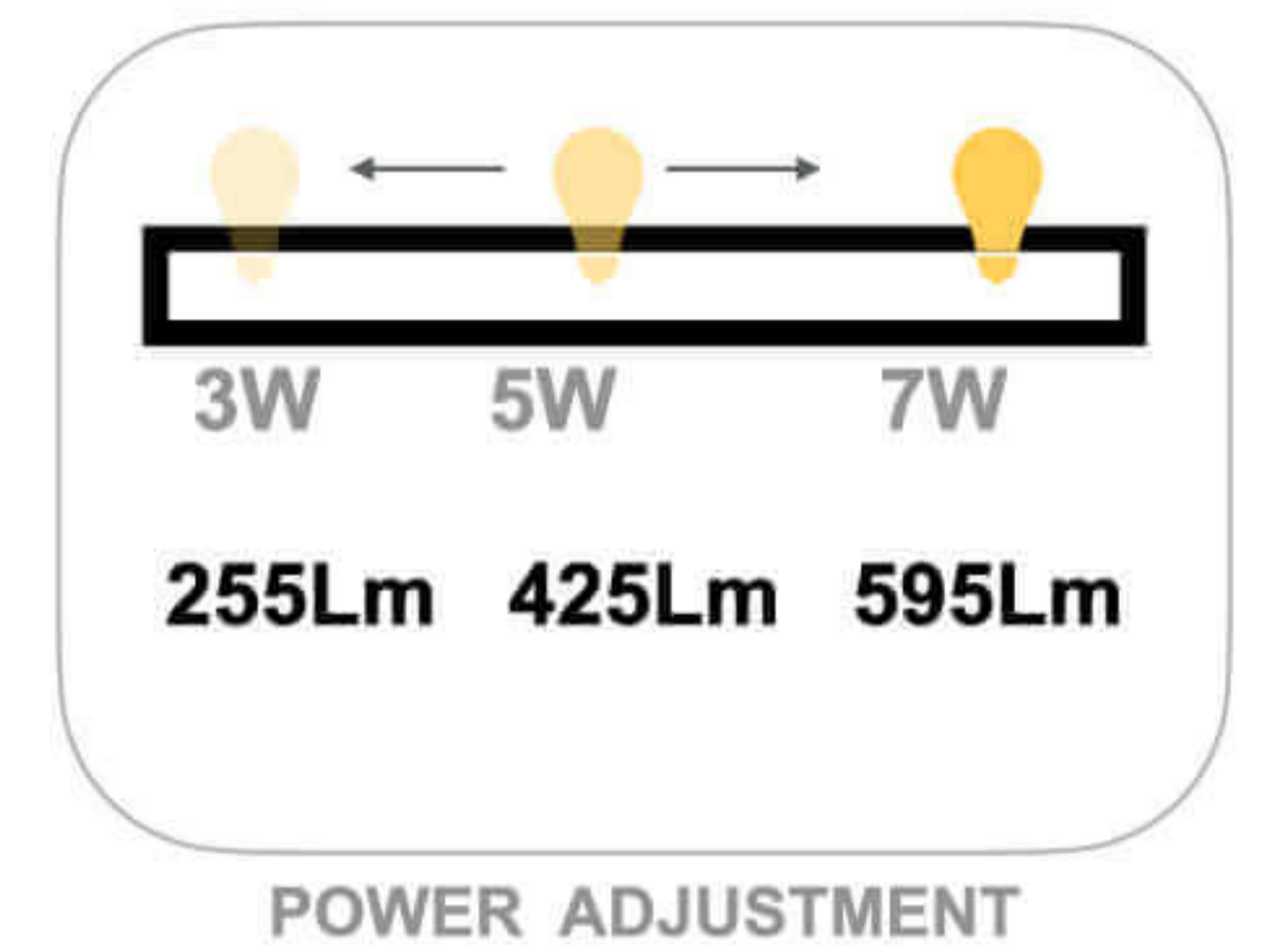
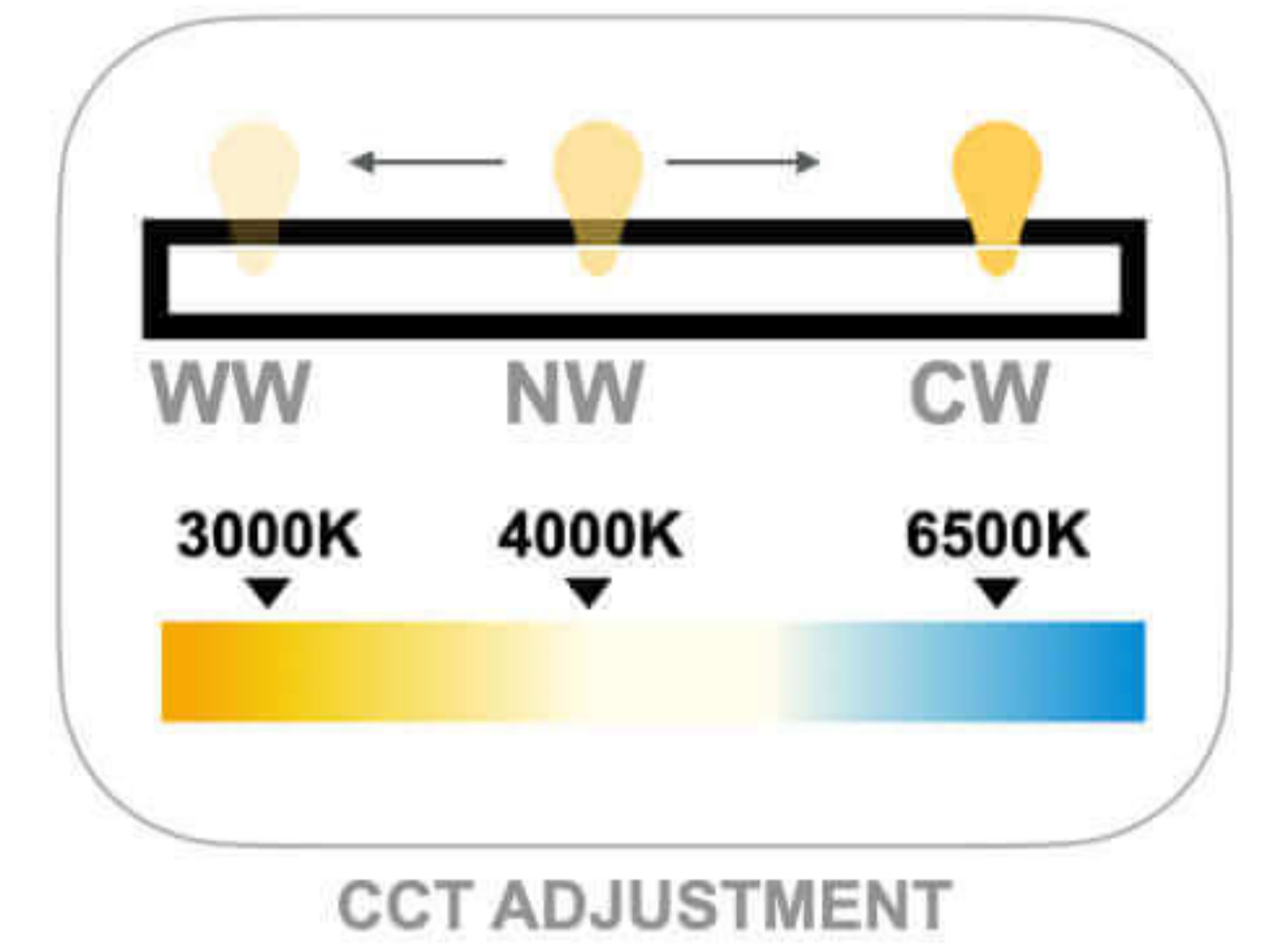

2 YEARS

SPECIFICATION

Normal

5w/7w
 220~240V
 85lm/w
 Ra(CRI) > 80
 PF > 0.5
 Linear IC Driver
 Size: ø90x23mm
 Cut Hole: 68-75mm
 2 years warranty
 CCT: 3000K, 4000K, 6500k

CCT Adjustable

5w/7w
 220~240V
 85lm/w
 Ra(CRI) > 80
 PF > 0.5
 Linear IC Driver
 Size: ø90x23mm
 Cut Hole: 68-75mm
 2 years warranty
 CCT: 3000K → 4000K → 6500K

CCT & Power Adjustable

3W → 5W → 7W
 220~240V
 85lm/w
 Ra(CRI) > 80
 PF > 0.5
 Linear IC Driver
 Size: ø90x23mm
 Cut Hole: 68-75mm
 2 years warranty
 CCT: 3000K → 4000K → 6500K

LED SLIM DOWNLIGHT

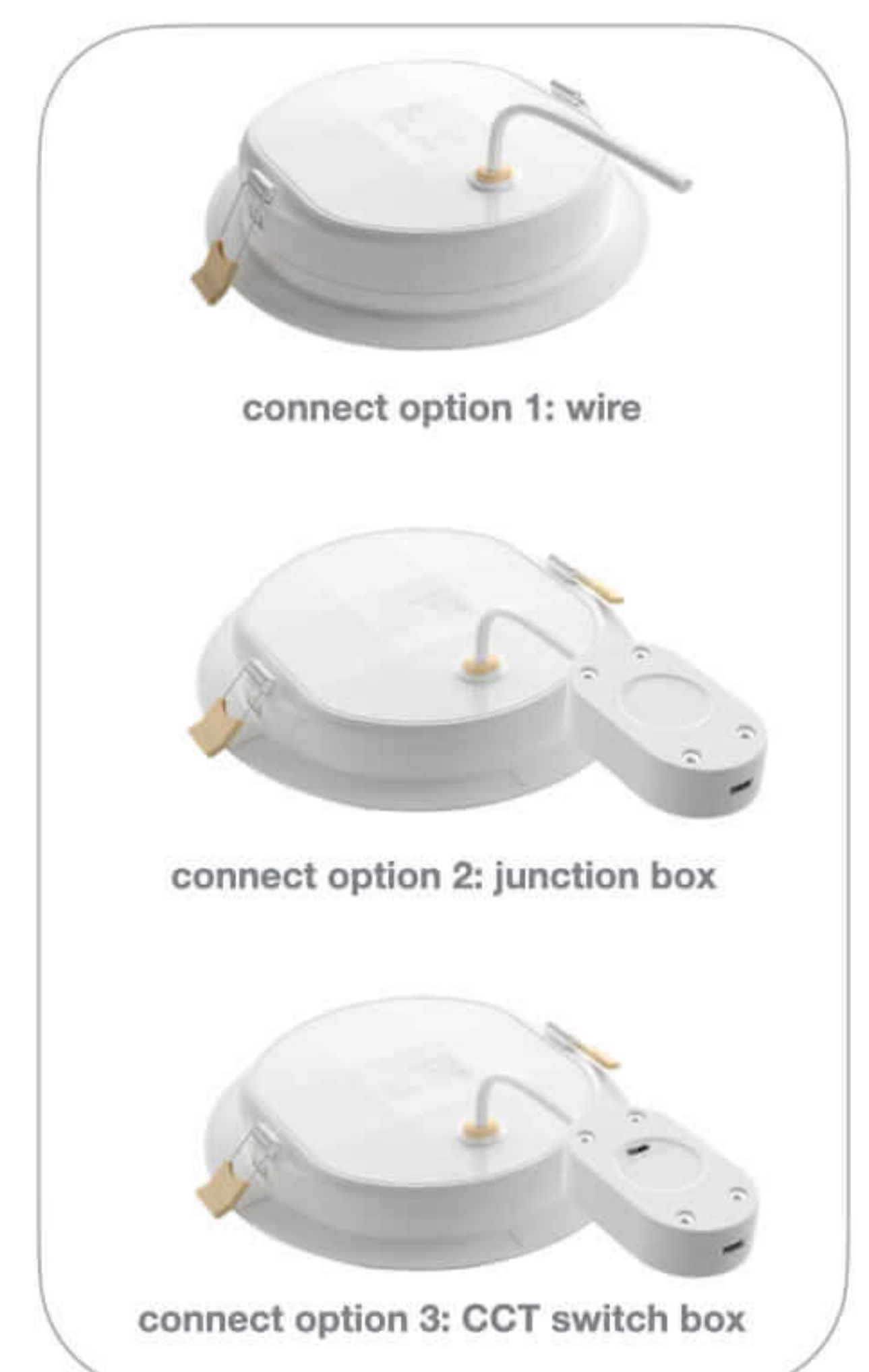
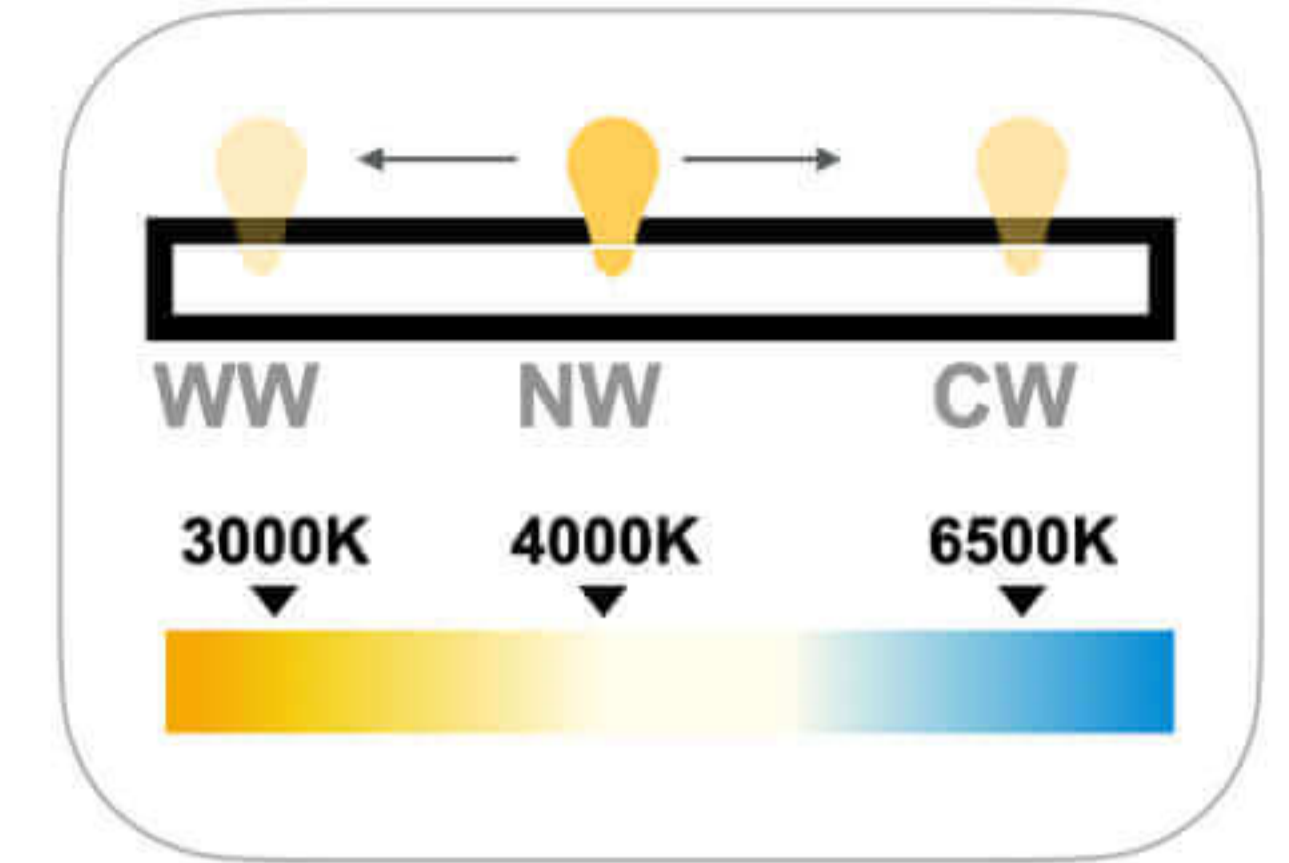
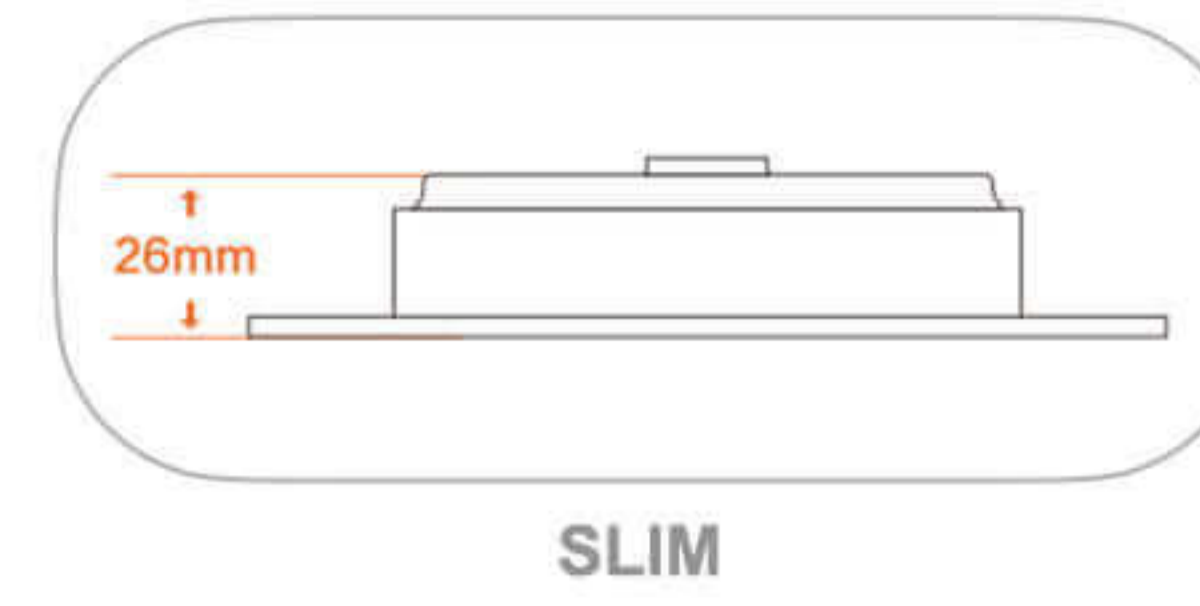

2 YEARS SPECIFICATION

ET-PDL-5W-R/S

5w
170-260V
100lm/w
Ra(CRI) > 80
PF > 0.5
IC Driver
Size: $\Phi 95 \times H26\text{mm}$
Cut Hole: $\Phi 75-90\text{mm}$

ET-PDL-9W-R/S

9w
170-260V
100lm/w
Ra(CRI) > 80
PF > 0.5
IC Driver
Size: $\Phi 120 \times H26\text{mm}$
Cut Hole: $\Phi 90-110\text{mm}$

ET-PDL-12W-R/S

12w
170-260V
100lm/w
Ra(CRI) > 80
PF > 0.5
IC Driver
Size: $\Phi 145 \times H26\text{mm}$
Cut Hole: $\Phi 120-135\text{mm}$

ET-PDL-18W-R/S

18w
170-260V
100lm/w
Ra(CRI) > 80
PF > 0.5
IC Driver
Size: $\Phi 170 \times H26\text{mm}$
Cut Hole: $\Phi 140-160\text{mm}$

ET-PDL-24W-R/S

24w
170-260V
100lm/w
Ra(CRI) > 80
PF > 0.5
IC Driver
Size: $\Phi 220 \times H26\text{mm}$
Cut Hole: $\Phi 190-210\text{mm}$

ADVANCED
LED SLIM CEILING LIGHT



2 Years
Warranty

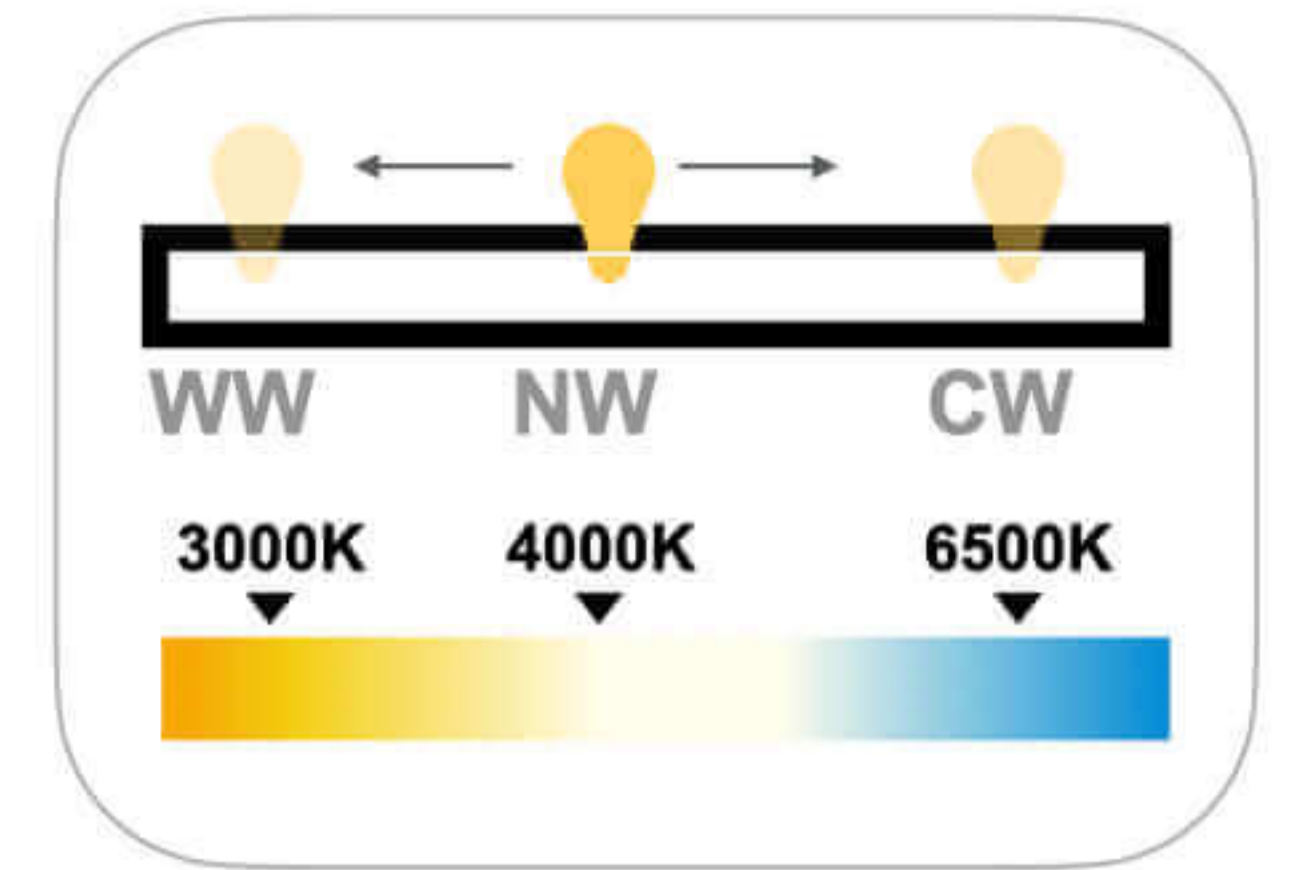

CCT ADJUSTMENT

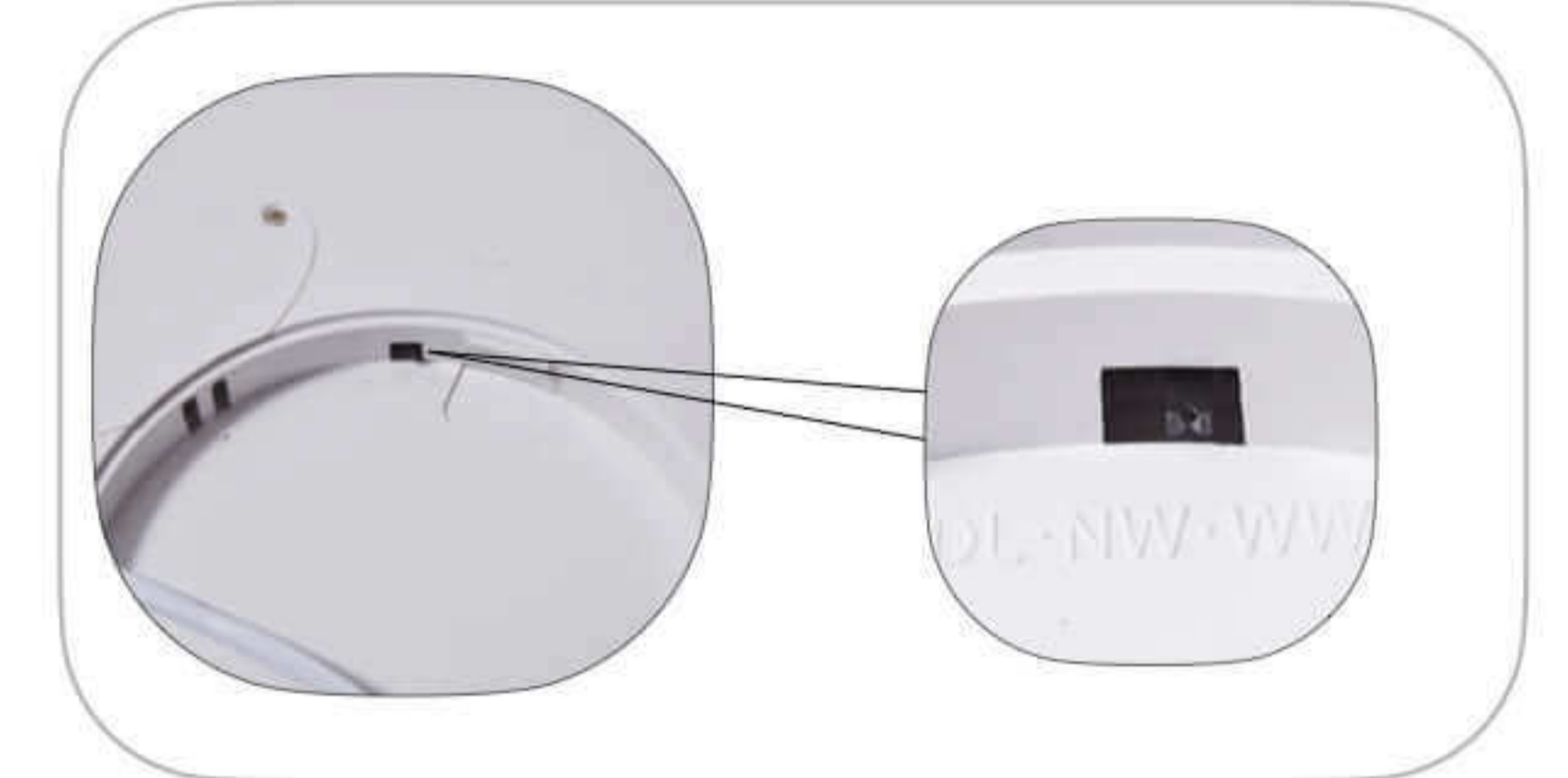

CCT Adjustable

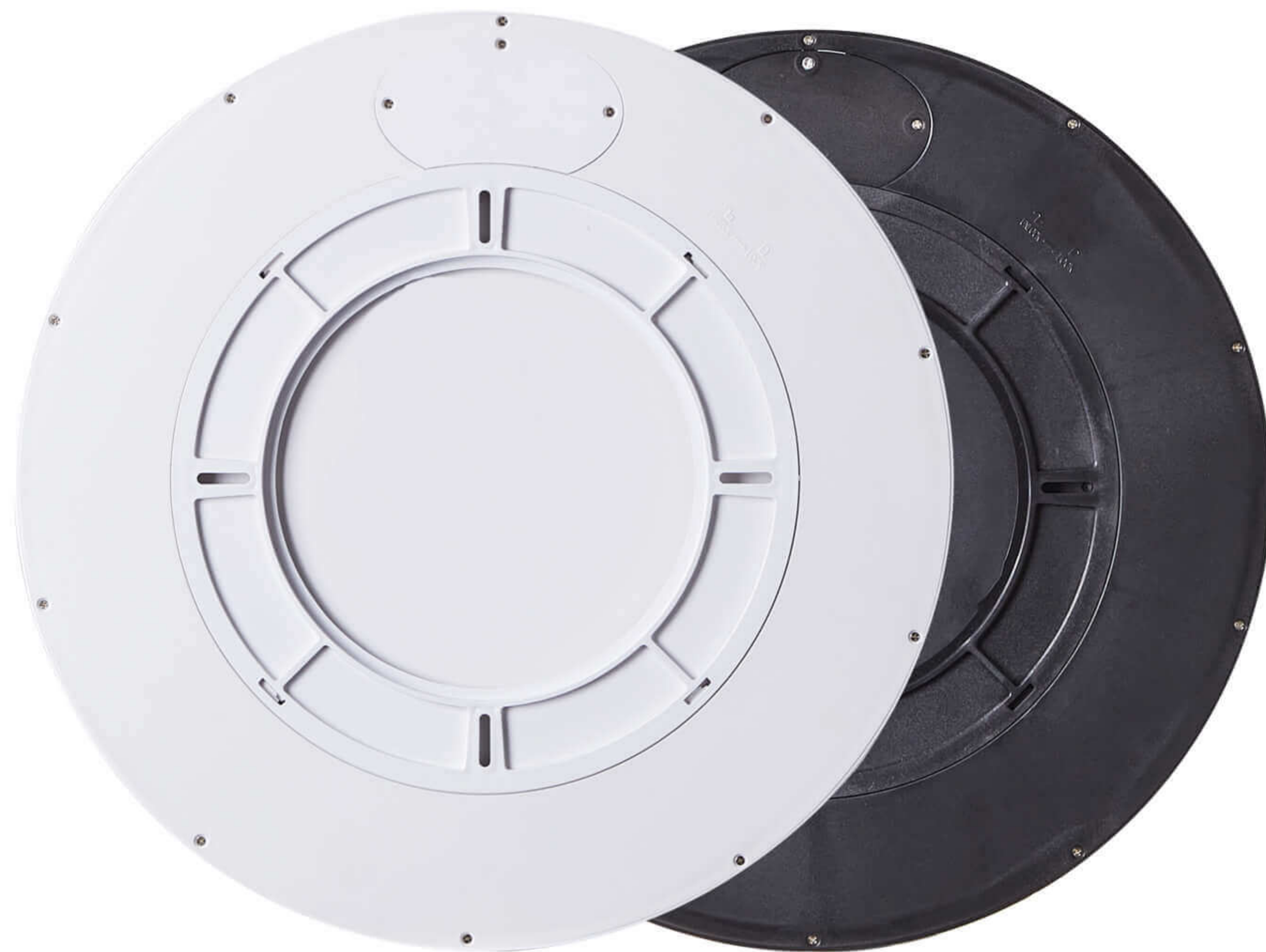

2 YEARS
SPECIFICATION

ET-SCL-18W-CCT	ET-SCL-24W-CCT	ET-SCL-32W-CCT	ET-SCL-40W-CCT	ET-SCL-50W-CCT	ET-SCL-70W-CCT
18W 220~240V 90lm/w Ra(CRI) > 80 PF≥0.5 IC Driver Size: φ235x24mm	24W 220~240V 90lm/w Ra(CRI) > 80 PF≥0.5 IC Driver Size: φ305x24mm	32W 220~240V 90lm/w Ra(CRI) > 80 PF≥0.9 IC Driver Size: φ405x24mm	40W 220~240V 90lm/w Ra(CRI) > 80 PF≥0.9 IC Driver Size: φ500x24mm	50W 220~240V 90lm/w Ra(CRI) > 80 PF≥0.9 IC Driver Size: φ600x24mm	70W 220~240V 90lm/w Ra(CRI) > 80 PF≥0.9 IC Driver Size: φ750x27mm

LED INDOOR LIST

T8 TUBE

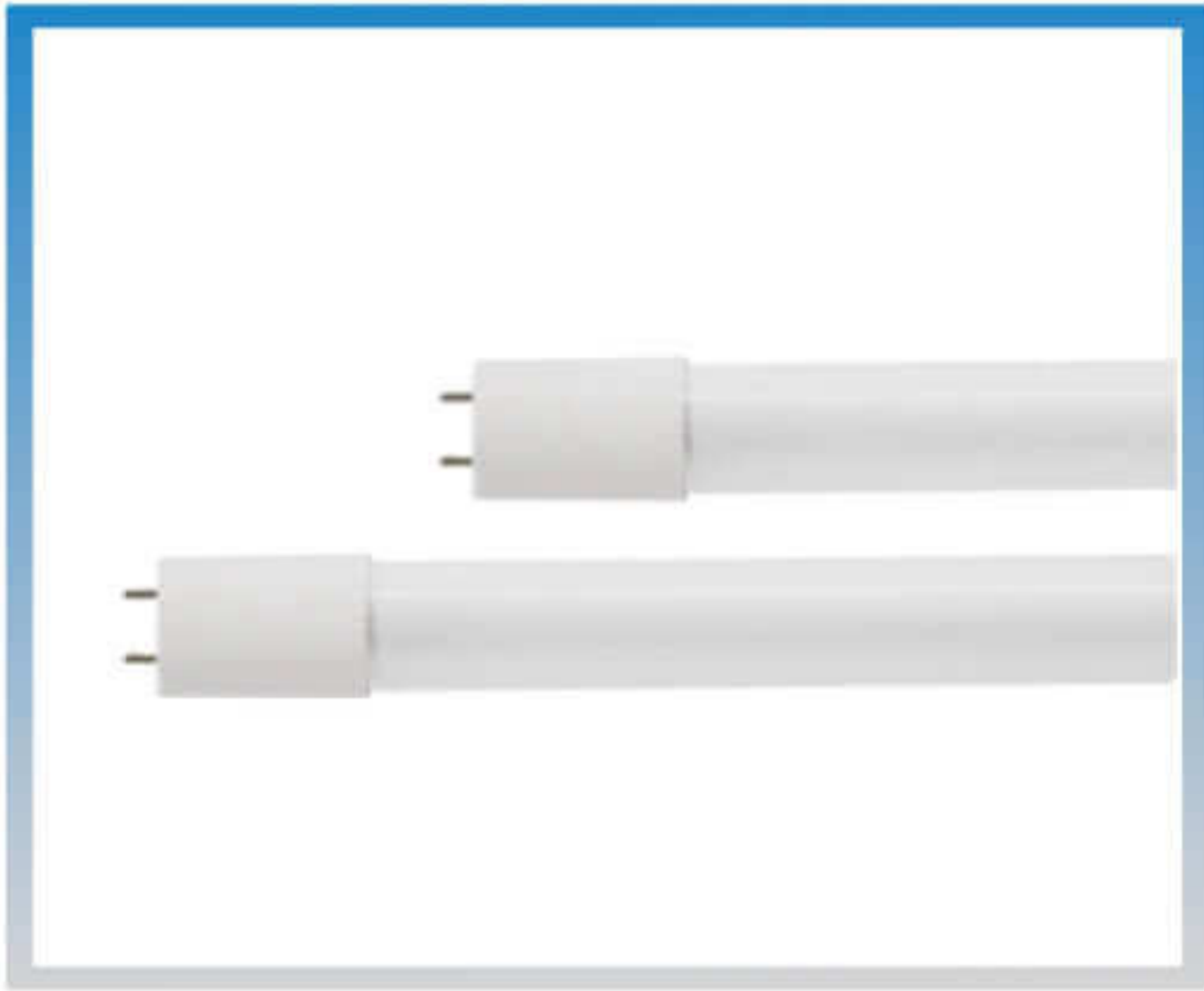

T8 GLASS TUBE

MINI T LAMP



T35 & T37

BULB



A50 || A55 || A60 || A65 || A70 || A80

PHOTOCEL BULB



C37 || G45 || R LAMP

MINI LAMP



C37 || G45 || R LAMP

SPOTLIGHT-1



GU10 || MR16

SPOTLIGHT-2



MR16 (5YEARS)

OTHERS



GX53 || AR111 || PAR30/38

HIGH POWER || T LAMP



ALU+PLASTIC MAX-60W



ALUMINUM MAX-100W



ALUMINUM MAX-200W

LOTUS LAMP



ET-LL

GARAGE LAMP (FOLDABLE)



ET-FGL

DECORATIVE



FILAMENT || G4 || G9 || R7S

LED FOLDABLE GARAGE LAMP

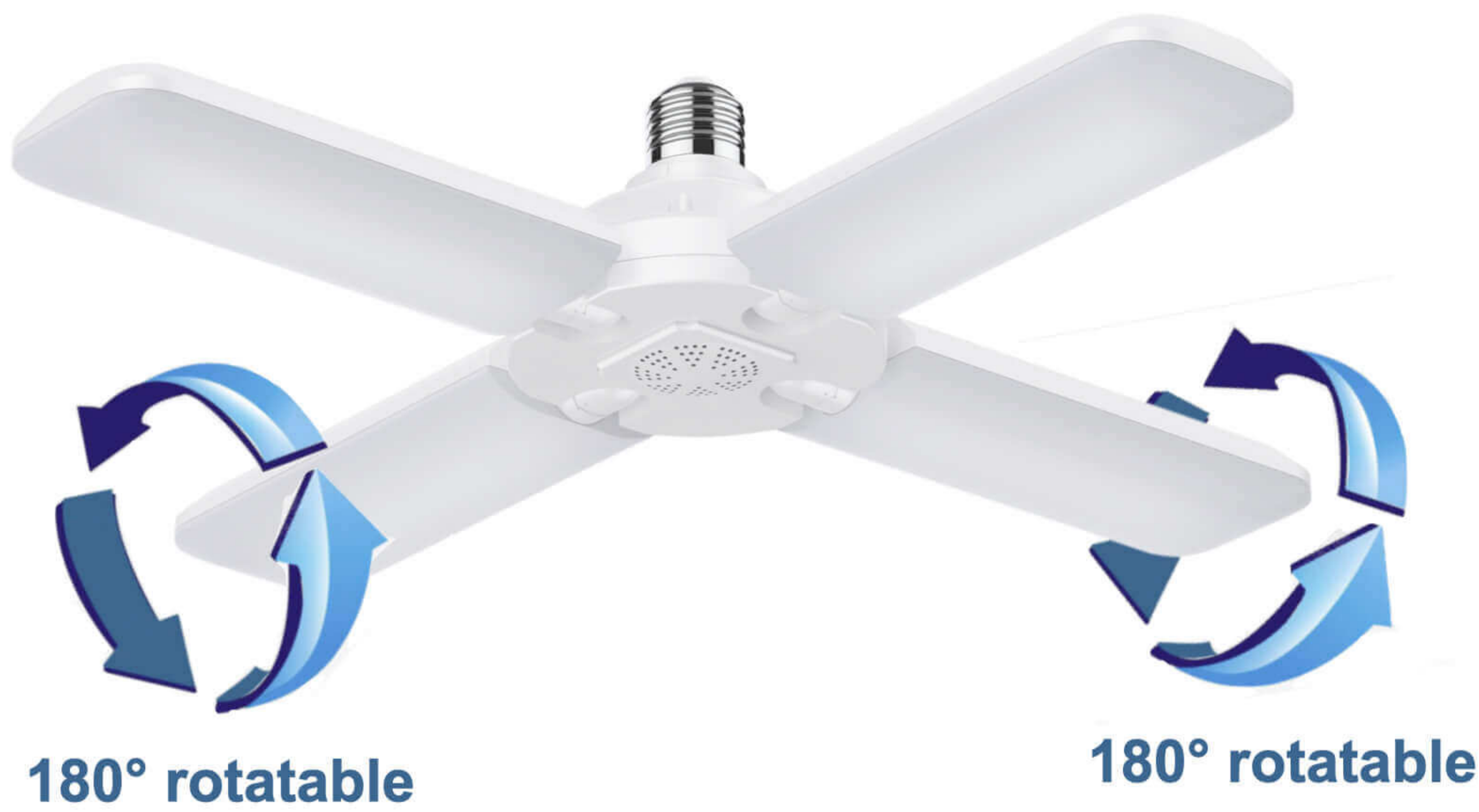

4 leaves



2 leaves



3 leaves



All leaves 180° rotation

100lm/w

2 Years Warranty



SPECIFICATION

ET-FGL26W-2

26w
180-265V
100lm/w
Ra(CRI) > 80
PF > 0.5
IC Driver
Size: Φ234×76mm

ET-FGL39W-3

39w
180-265V
100lm/w
Ra(CRI) > 80
PF > 0.5
IC Driver
Size: Φ234×80mm

ET-FGL52W-4

52w
180-265V
100lm/w
Ra(CRI) > 80
PF > 0.5
IC Driver
Size: Φ234×90mm

LED LOTUS LAMP



**2 Years
Warranty**

100lm/w

**300°
Beam angle**



E27 / E40

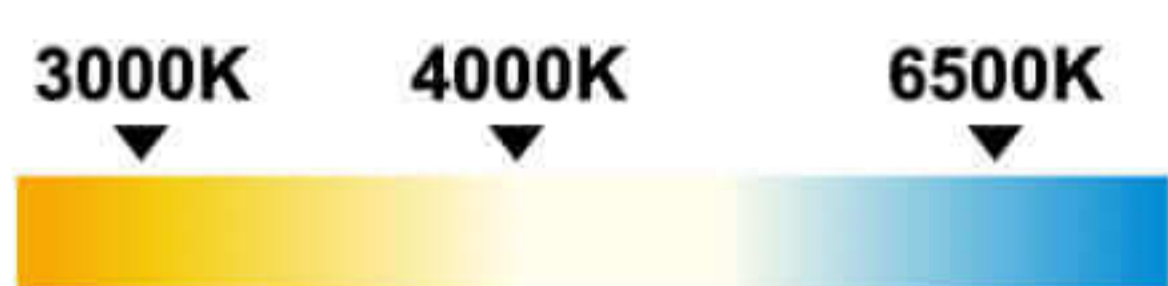

SPECIFICATION

ET-LL-30W

30w
AC 180-265V
100lm/w
Ra(CRI) > 80
PF > 0.5
IC Driver
Size: Φ98*223mm

ET-LL-40W

40w
AC 180-265V
100lm/w
Ra(CRI) > 80
PF > 0.5
IC Driver
Size: Φ110*255mm

ET-LL-50W

50w
AC 180-265V
100lm/w
Ra(CRI) > 80
PF > 0.5
IC Driver
Size: Φ110*255mm

ET-LL-60W

60w
AC 180-265V
100lm/w
Ra(CRI) > 80
PF > 0.5
IC Driver
Size: Φ126*296mm

Why are we here?

To be your reliable and professional lamp partner & bring you more profit.

One more alternative supplier is not a bad thing!

Larry
Project Manager
Business Manager

-  : +86 13566304709
(WeChat/WhatsApp)
-  : larry.k@eytonlighting.com
-  : www.eytonlighting.com
-  : No.1628 SongJiang East RD, Yinzhou, Ningbo, China

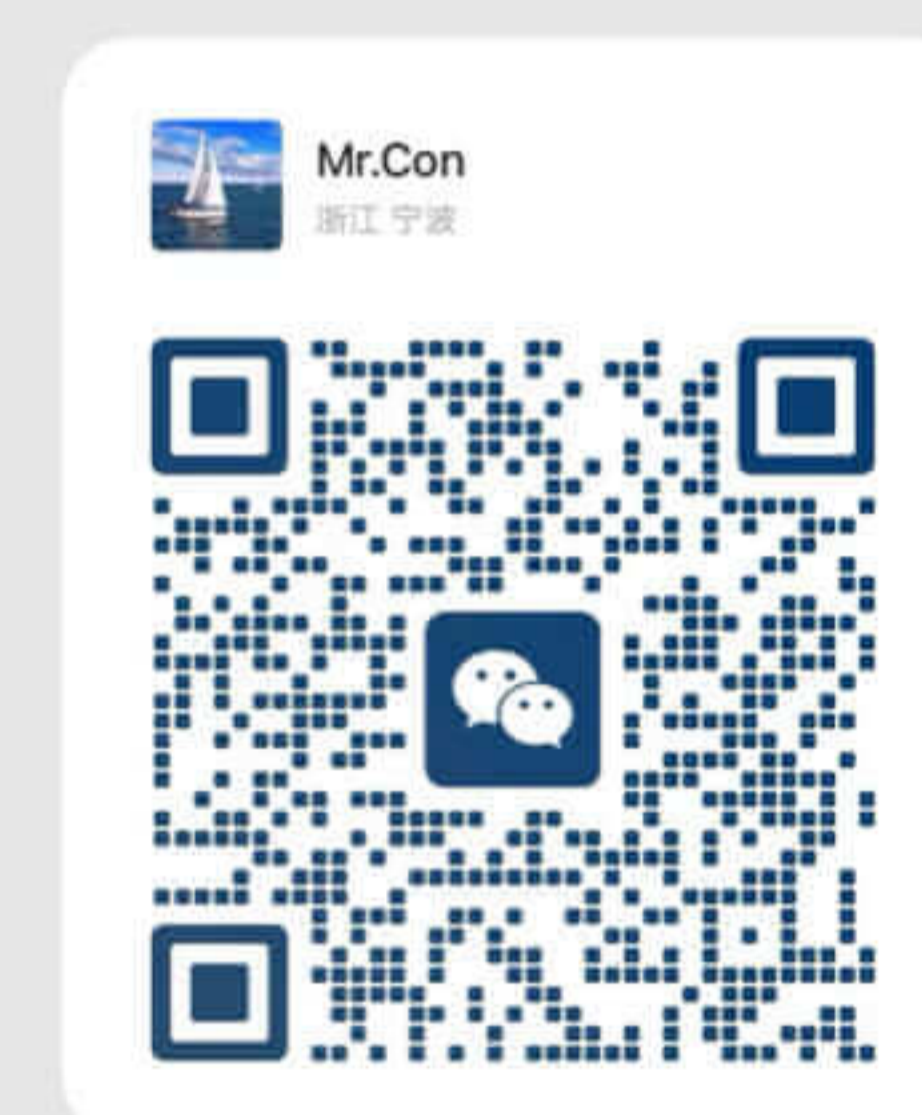

Anthony Gao
Product Optimization Manager

-  : +86 18255159819
(WeChat/WhatsApp)
-  : anthony.g@eytonlighting.com
-  : www.eytonlighting.com
-  : No.1628 SongJiang East RD, Yinzhou, Ningbo, China

